

FAIM
Flügel Aussen
linker Mittelfalz

⊙ einstellehren 0 mm

A1	04.0.098	04.0.182.02 - 04.0.226			R3	04.0.322 - 04.0.932	
A2	04.1.197	04.2.310.23 - 04.0.226		5 mm	04.2.336 - 04.0.929		04.2.310.102 - 04.0.900
A3	04.1.197	04.2.310.23 - 04.0.226		5 mm	04.2.336 - 04.0.929	R2	04.0.332 - 04.0.314
					R3	04.0.321 - 04.0.910	

ABMESSUNGEN
DIMENSIONS
216x120x30

VORSCHUB
FEED
MAN

SIZE
A4

SCALE
1:1

LINEAREINHEIT
LINEAR DIMENSION
WINKELEINHEIT
ANGULAR SIZE
MM

RPM
3800-6500

MESSERMATERIAL
KNIFE MATERIAL
HW

ARTIKEL
ITEM
04.1.380

GAUGE

2

Diese Zeichnung ist Eigentum der Firma FELDER KG und darf ohne Erlaubnis weder veräußert, kopiert, noch dritten Personen oder Konkurrenzfirmen mitgeteilt werden. Zuwiderhandlungen werden dem Gesetz entsprechend gerichtlich verfolgt!

This drawing is property of FELDER KG and may not be released, reproduced nor communicated to third parties or rival firms. Violations will result in judicial persecution in accordance with the law!

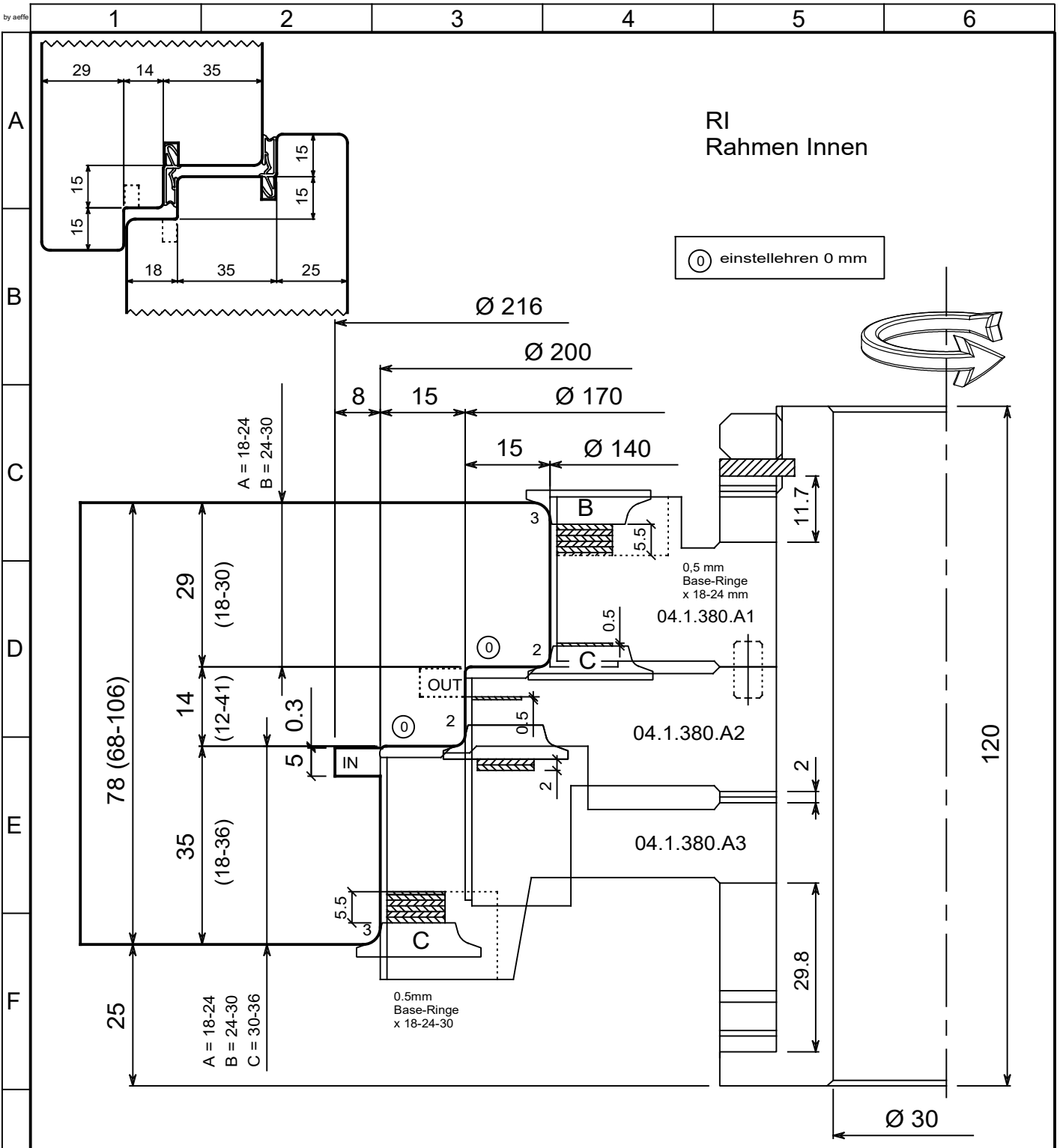

A1	04.0.098	04.0.182.02 - 04.0.226			R3	04.0.322 - 04.0.932	
A2	04.1.197	04.2.310.23 - 04.0.226		5 mm	04.2.336 - 04.0.929		04.2.310.102 - 04.0.900
A3	04.1.197	04.2.310.23 - 04.0.226		5 mm	04.2.336 - 04.0.929	R2	04.0.332 - 04.0.314
					R3	04.0.321 - 04.0.910	

ABMESSUNGEN DIMENSIONS: 216x120x30

VORSCHUB FEED: MAN

SIZE: A4

SCALE: 1:1

LINEAREINHEIT LINEAR DIMENSION: MM

WINKLEINHEIT ANGULAR SIZE: °

RPM: 3800-6500

MESSERMATERIAL KNIFE MATERIAL: HW

ARTIKEL ITEM: 04.1.380

GAUGE: 0 1, 0.4 1.5

Z: 2

Diese Zeichnung ist Eigentum der Firma FELDER KG und darf ohne Erlaubnis weder veräußert, kopiert, noch dritten Personen oder Konkurrenzfirmen mitgeteilt werden. Zuwiderhandlungen werden dem Gesetz entsprechend gerichtlich verfolgt!

This drawing is property of FELDER KG and may not be released, reproduced nor communicated to third parties or rival firms. Violations will result in judicial persecution in accordance with the law!

FELDER KG, KR-Felder-Straße 1, 6060 Hall in Tirol, AUSTRIA, Tel. +43 5223 58500, Fax. +43 5223 56130, info@felder-group.com, www.felder-group.com

G0354591

A

B

C

D

E

F

G

H

L

OPTIONAL
NUTMESSER

FA
Flügel Aussen

⊙ einstellehren 0 mm

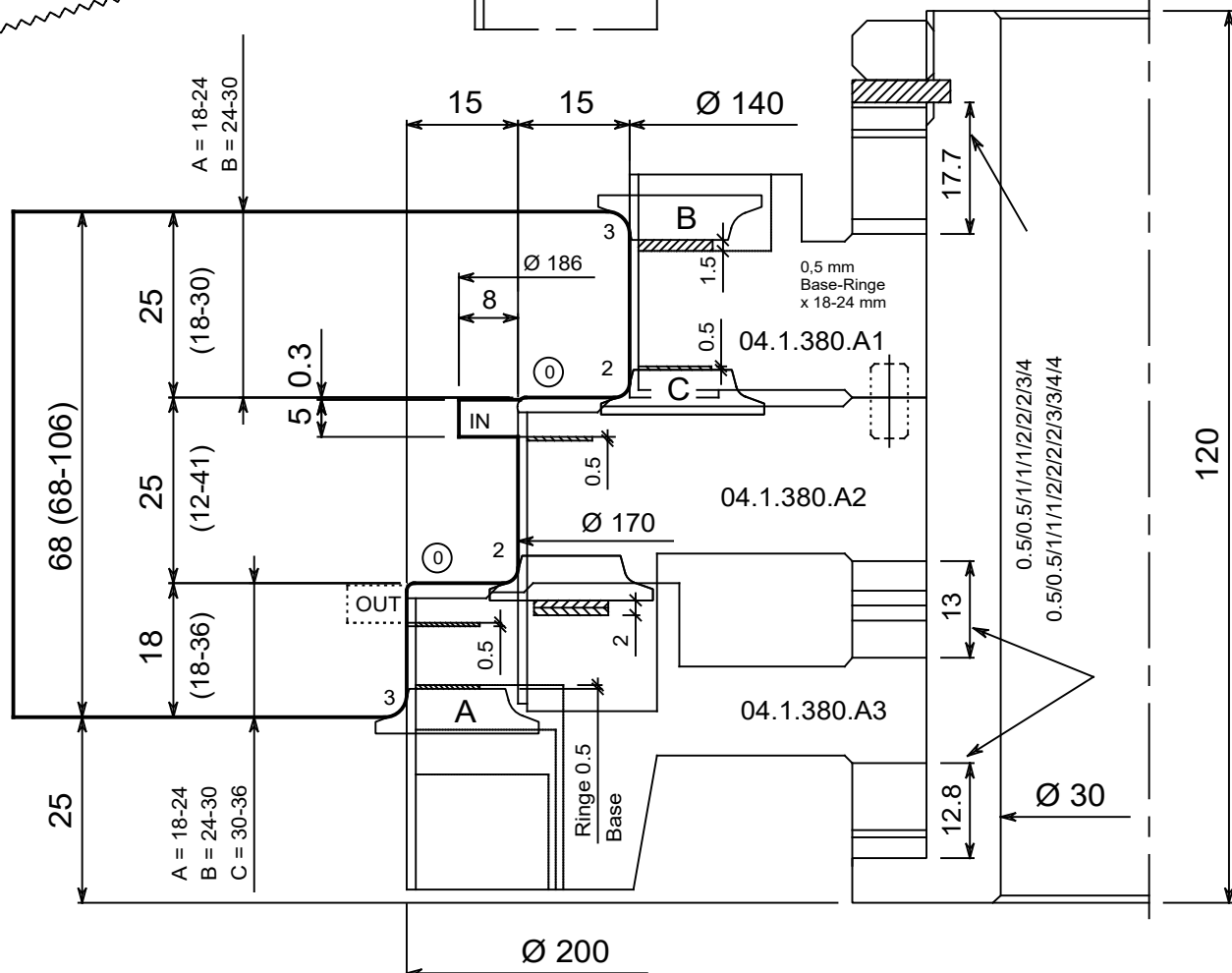
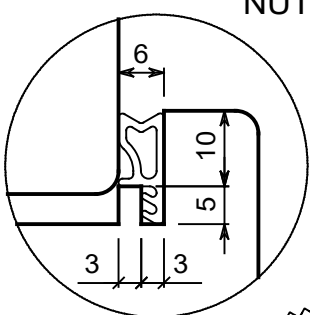

A1	04.0.098	04.0.182.02 - 04.0.226			R3	04.0.322 - 04.0.932	
A2	04.1.197	04.2.310.23 - 04.0.226	5 mm	04.2.336 - 04.0.929	R2	04.0.332 - 04.0.314	04.2.310.102 - 04.0.900
A3	04.1.197	04.2.310.23 - 04.0.226	5 mm	04.2.336 - 04.0.929	R2	04.0.332 - 04.0.314	04.2.310.102 - 04.0.916
					R3	04.0.321 - 04.0.910	

ABMESSUNGEN
DIMENSIONS
216x120x30

VORSCHUB
FEED
MAN

SIZE
A4

SCALE
1:1

LINEAREINHEIT
LINEAR DIMENSION
WINKLEINHEIT
ANGULAR SIZE
MM

RPM
3800-6500

MESSERMATERIAL
KNIFE MATERIAL
HW

ARTIKEL
ITEM
04.1.380

GAUGE
2

⊙ 1
⊙ 0.4 1.5

Diese Zeichnung ist Eigentum der Firma **FELDER KG** und darf ohne Erlaubnis weder veräußert, kopiert, noch dritten Personen oder Konkurrenzfirmen mitgeteilt werden. Zuwiderhandlungen werden dem Gesetz entsprechend gerichtlich verfolgt!

This drawing is property of **FELDER KG** and may not be released, reproduced nor communicated to third parties or rival firms. Violations will result in judicial persecution in accordance with the law!

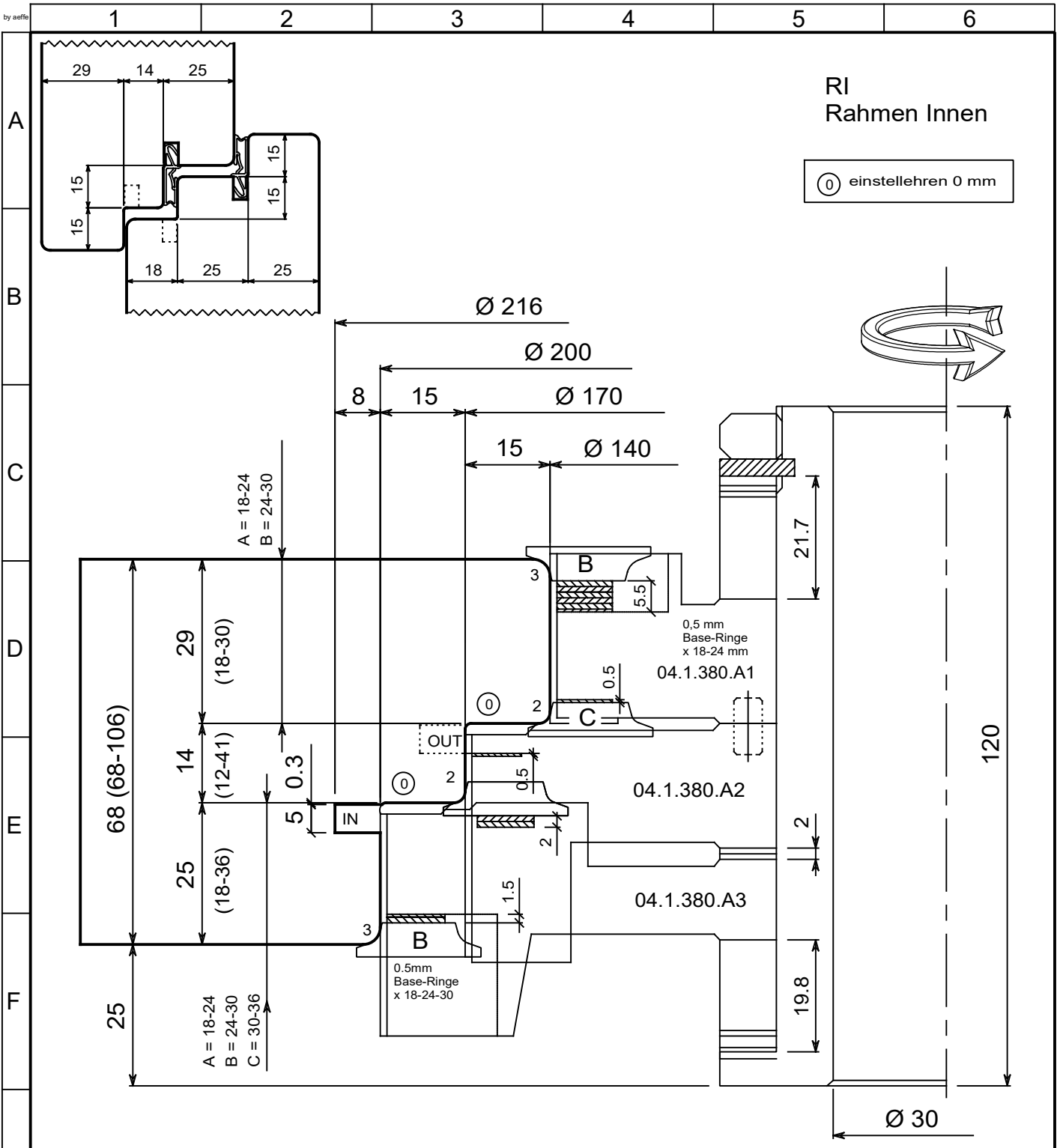

A1	04.0.098	04.0.182.02 - 04.0.226			R3	04.0.322 - 04.0.932	
A2	04.1.197	04.2.310.23 - 04.0.226	5 mm	04.2.336 - 04.0.929			04.2.310.102 - 04.0.900
A3	04.1.197	04.2.310.23 - 04.0.226	5 mm	04.2.336 - 04.0.929	R2	04.0.332 - 04.0.314	04.2.310.102 - 04.0.916
					R3	04.0.321 - 04.0.910	

ABMESSUNGEN DIMENSIONS: 216x120x30

VORSCHUB FEED: MAN

SIZE: A4

SCALE: 1:1

LINEAREINHEIT LINEAR DIMENSION: MM

WINKLEINHEIT ANGULAR SIZE: °

RPM: 3800-6500

MESSERMATERIAL KNIFE MATERIAL: HW

ARTIKEL ITEM: 04.1.380

GAUGE: 0 1, 0.4 1.5

Z: 2

Diese Zeichnung ist Eigentum der Firma FELDER KG und darf ohne Erlaubnis weder veräußert, kopiert, noch dritten Personen oder Konkurrenzfirmen mitgeteilt werden. Zuwiderhandlungen werden dem Gesetz entsprechend gerichtlich verfolgt!

This drawing is property of FELDER KG and may not be released, reproduced nor communicated to third parties or rival firms. Violations will result in judicial persecution in accordance with the law!

FELDER KG, KR-Felder-Straße 1, 6060 Hall in Tirol, AUSTRIA, Tel. +43 5223 58500, Fax. +43 5223 56130, info@felder-group.com, www.felder-group.com

G0354611

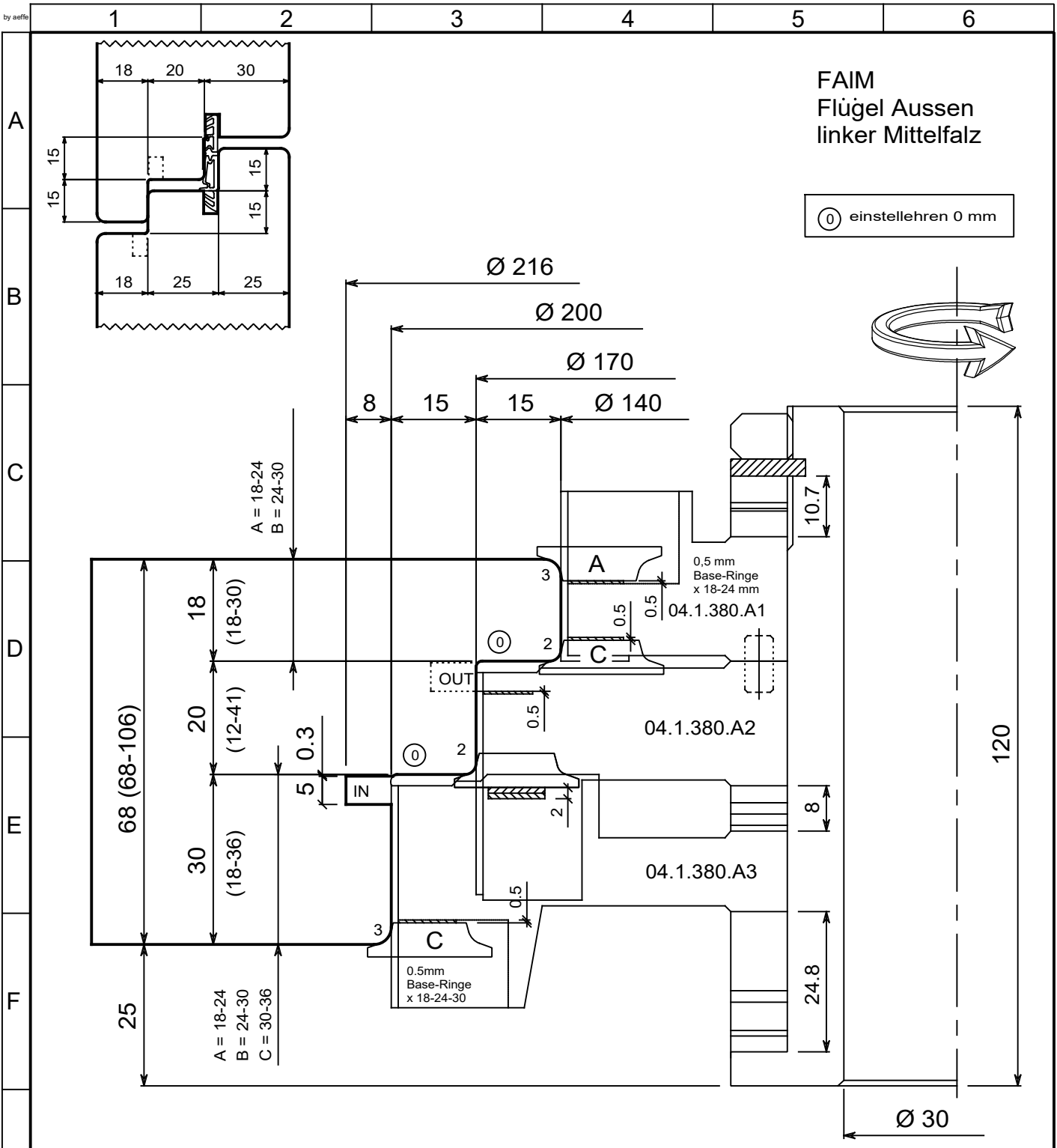

A1	04.0.098	04.0.182.02 - 04.0.226			R3	04.0.322 - 04.0.932	
A2	04.1.197	04.2.310.23 - 04.0.226	5 mm	04.2.336 - 04.0.929	R2	04.0.332 - 04.0.314	04.2.310.102 - 04.0.900
A3	04.1.197	04.2.310.23 - 04.0.226	5 mm	04.2.336 - 04.0.929	R2	04.0.332 - 04.0.314	04.2.310.102 - 04.0.916
					R3	04.0.321 - 04.0.910	

	ABMESSUNGEN DIMENSIONS 216x120x30	RPM 3800-6500	GAUGE 0 1 0.4 1.5
	VORSCHUB FEED MAN	MESSERMATERIAL KNIFE MATERIAL HW	Z 2
Diese Zeichnung ist Eigentum der Firma FELDER KG und darf ohne Erlaubnis weder veräußert, kopiert, noch dritten Personen oder Konkurrenzfirmen mitgeteilt werden. Zuwiderhandlungen werden dem Gesetz entsprechend gerichtlich verfolgt!	This drawing is property of FELDER KG and may not be released, reproduced nor communicated to third parties or rival firms. Violations will result in judicial persecution in accordance with the law!	SIZE A4	SCALE 1:1
LINEAREINHEIT LINEAR DIMENSION WINKLEINHEIT ANGULAR SIZE MM		ARTIKEL ITEM 04.1.380	
FELDER KG, KR-Felder-Straße 1, 6060 Hall in Tirol, AUSTRIA, Tel. +43 5223 58500, Fax. +43 5223 56130, info@felder-group.com, www.felder-group.com			G0354621

A

B

C

D

E

F

G

H

L

OPTIONAL
NUTMESSER

FA
Flügel Aussen

⊙ einstellbar 0 mm

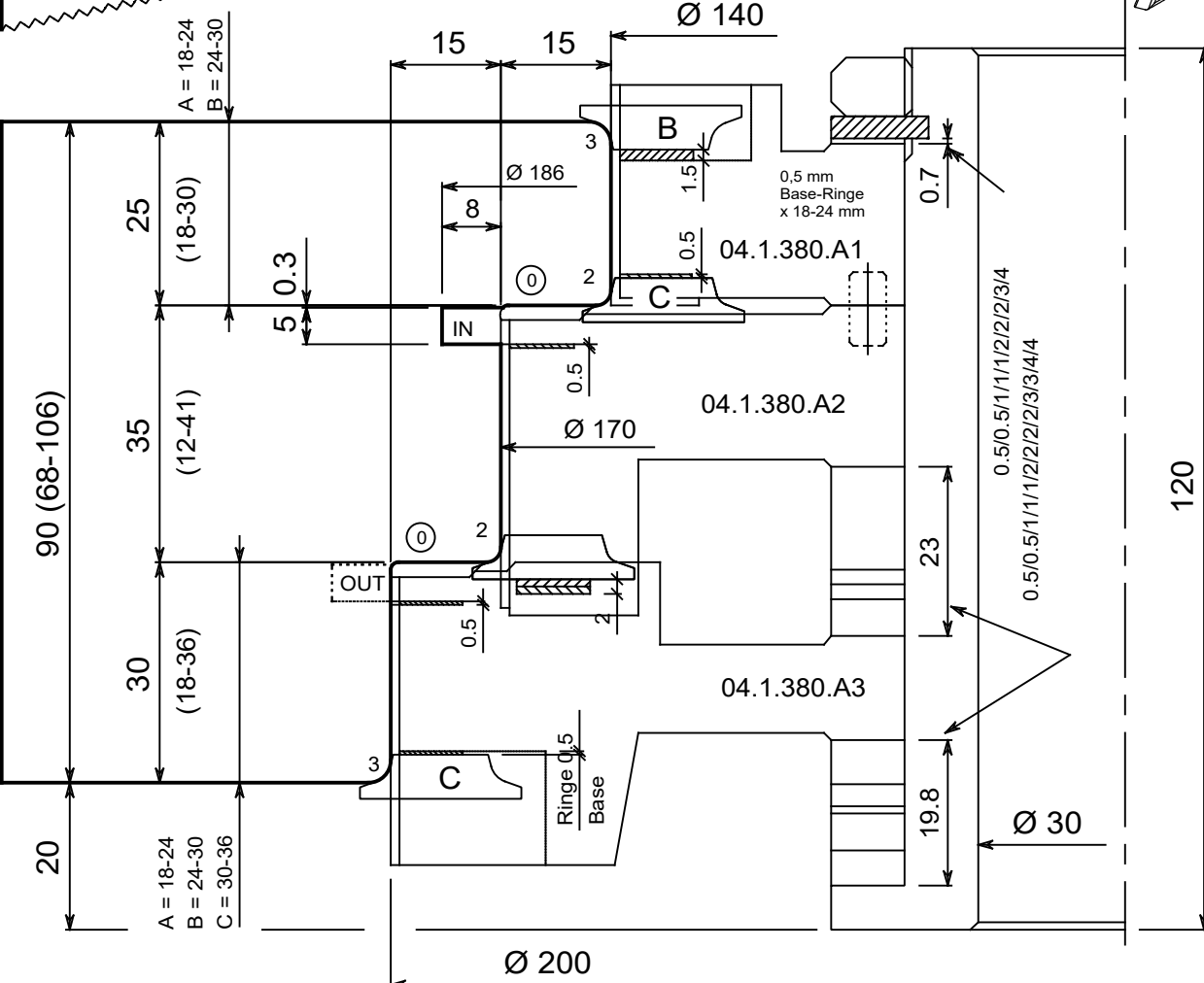
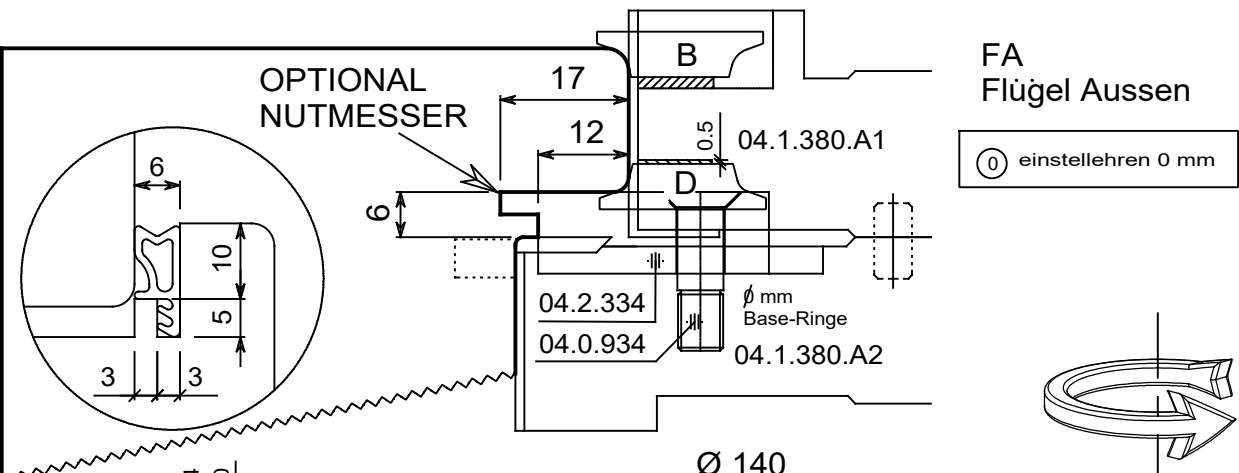

A1	04.0.098	04.0.182.02 - 04.0.226			R3	04.0.322 - 04.0.932	
A2	04.1.197	04.2.310.23 - 04.0.226		5 mm	04.2.336 - 04.0.929		04.2.310.102 - 04.0.900
A3	04.1.197	04.2.310.23 - 04.0.226		5 mm	04.2.336 - 04.0.929	R2	04.0.332 - 04.0.314
						R3	04.0.321 - 04.0.910

ABMESSUNGEN
DIMENSIONS
216x120x30

RPM
3800-6500

GAUGE
⊙ 1
⊙ 0.4 1.5

VORSCHUB
FEED
MAN

MESSERMATERIAL
KNIFE MATERIAL
HW

Z
2

SIZE
A4

SCALE
1:1

ARTIKEL
ITEM
04.1.380

LINEAREINHEIT
LINEAR DIMENSION
WINKLEINHEIT
ANGULAR SIZE
MM

04.1.380

Diese Zeichnung ist Eigentum der Firma **FELDER KG** und darf ohne Erlaubnis weder veräußert, kopiert, noch dritten Personen oder Konkurrenzfirmen mitgeteilt werden. Zuwiderhandlungen werden dem Gesetz entsprechend gerichtlich verfolgt!

This drawing is property of **FELDER KG** and may not be released, reproduced nor communicated to third parties or rival firms. Violations will result in judicial persecution in accordance with the law!

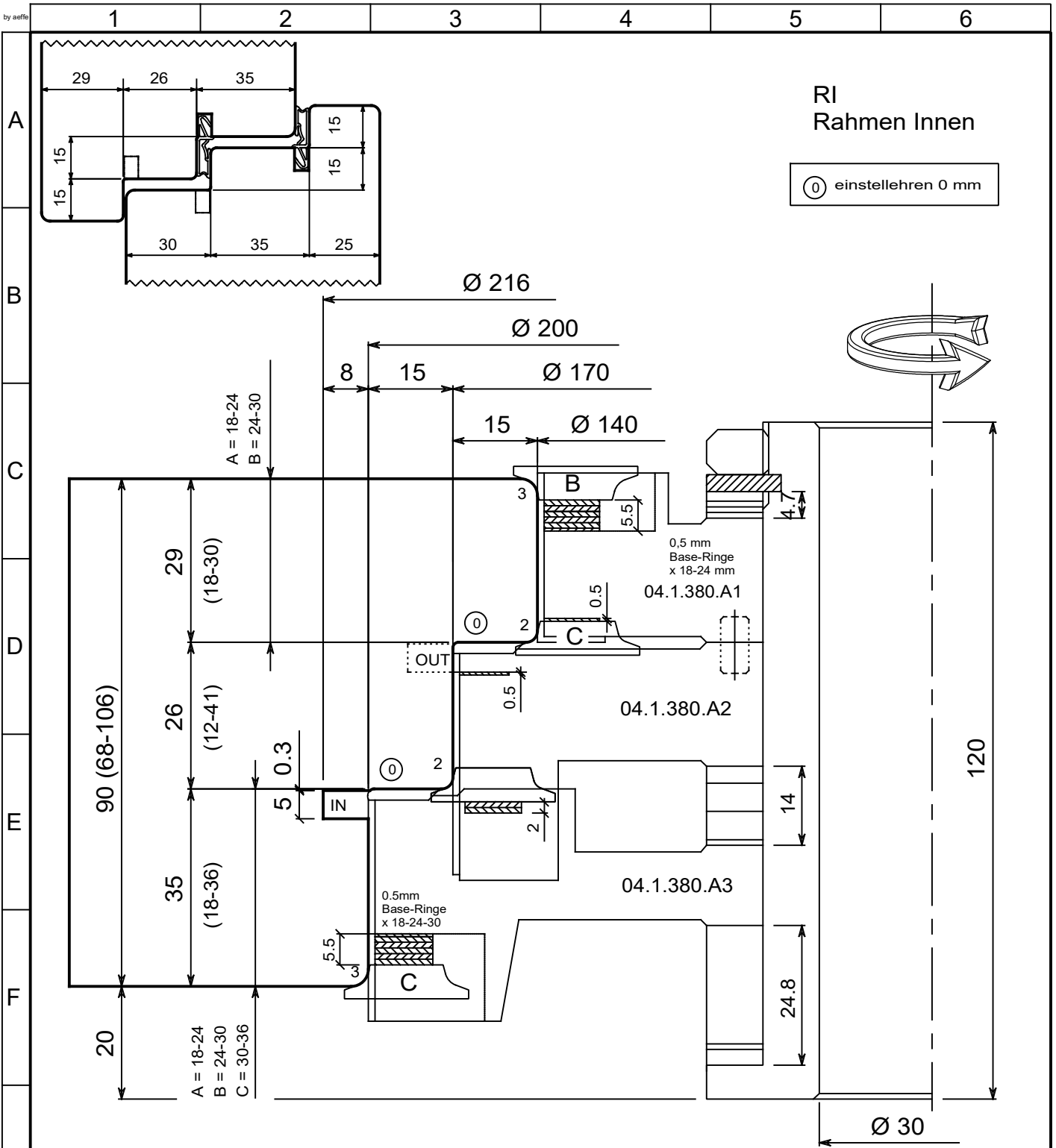

A1	04.0.098	04.0.182.02 - 04.0.226			R3	04.0.322 - 04.0.932			
A2	04.1.197	04.2.310.23 - 04.0.226		5 mm	04.2.336 - 04.0.929		04.2.310.102 - 04.0.900		
A3	04.1.197	04.2.310.23 - 04.0.226		5 mm	04.2.336 - 04.0.929		R2	04.0.332 - 04.0.314	
					R3	04.0.321 - 04.0.910		04.2.310.102 - 04.0.916	

	ABMESSUNGEN DIMENSIONS 216x120x30	RPM 3800-6500	GAUGE 0 1 0.4 1.5
	VORSCHUB FEED MAN	MESSERMATERIAL KNIFE MATERIAL HW	Z 2
Diese Zeichnung ist Eigentum der Firma FELDER KG und darf ohne Erlaubnis weder veräußert, kopiert, noch dritten Personen oder Konkurrenzfirmen mitgeteilt werden. Zuwiderhandlungen werden dem Gesetz entsprechend gerichtlich verfolgt!	This drawing is property of FELDER KG and may not be released, reproduced nor communicated to third parties or rival firms. Violations will result in judicial persecution in accordance with the law!	SIZE A4	SCALE 1:1
LINEAREINHEIT LINEAR DIMENSION WINKLEINHEIT ANGULAR SIZE MM		04.1.380	
FELDER KG, KR-Felder-Straße 1, 6060 Hall in Tirol, AUSTRIA, Tel. +43 5223 58500, Fax. +43 5223 56130, info@felder-group.com, www.felder-group.com			G0354641

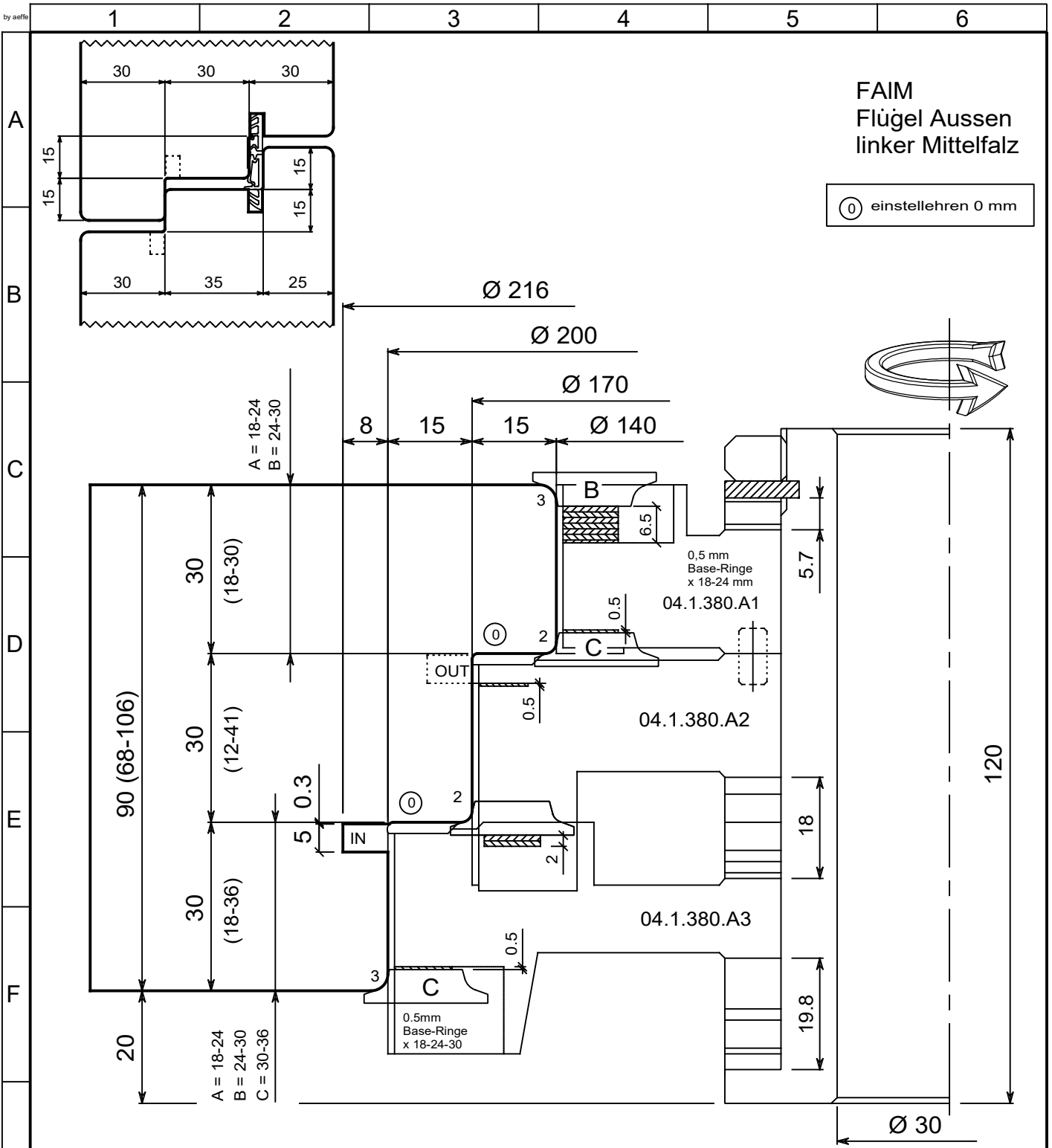

A1	04.0.098	04.0.182.02 - 04.0.226			R3	04.0.322 - 04.0.932	
A2	04.1.197	04.2.310.23 - 04.0.226		5 mm	R2	04.0.332 - 04.0.314	
A3	04.1.197	04.2.310.23 - 04.0.226		5 mm	R2	04.0.332 - 04.0.314	
					R3	04.0.321 - 04.0.910	

FELDER. *Silent POWER*

FELDER GROUP

ABMESSUNGEN DIMENSIONS
216x120x30

VORSCHUB FEED
MAN

SIZE
A4

SCALE
1:1

LINEAREINHEIT LINEAR DIMENSION
WINKLEINHEIT ANGULAR SIZE
MM

RPM
3800-6500

MESSERMATERIAL KNIFE MATERIAL
HW

ARTIKEL ITEM
04.1.380

GAUGE
2

⊙ 1
⊙ 0.4
⊙ 1.5

Diese Zeichnung ist Eigentum der Firma **FELDER KG** und darf ohne Erlaubnis weder veräußert, kopiert, noch dritten Personen oder Konkurrenzfirmen mitgeteilt werden. Zuwiderhandlungen werden dem Gesetz entsprechend gerichtlich verfolgt!

This drawing is property of **FELDER KG** and may not be released, reproduced nor communicated to third parties or rival firms. Violations will result in judicial persecution in accordance with the law!

FELDER KG, KR-Felder-Straße 1, 6060 Hall in Tirol, AUSTRIA, Tel. +43 5223 58500, Fax. +43 5223 56130, info@felder-group.com, www.felder-group.com

G0354651